



# TOYOTA

## Sienna Hybrid

*Manual Rear-Entry Conversion*



**OWNERS MANUAL**



**VANTAGE MOBILITY  
OWNER'S MANUAL**

**Toyota Sienna Hybrid**  
Manual Rear-Entry Conversion

**Introduction** ..... **2**

    Trademarks ..... 3

    Copyright © 2024 Vantage Mobility, LLC ..... 3

    Disclaimer ..... 3

    Record of Revisions ..... 3

**Safety Precautions** ..... **4**

**Equipment Guide** ..... **6**

    Vantage Mobility Installed Equipment ..... 6

    Vantage Mobility Dealer Installed Options ..... 6

**Ramp Operation** ..... **7**

    Deploy Ramp ..... 7

    Stow Ramp ..... 8

**Seating and Securement** ..... **10**

    Wheelchair Restraint System ..... 10

    Mid-Row Seating ..... 10

    Mid-Row Child Seating ..... 11

    Vehicle Load Capacity ..... 12

    Restraint Belt Positioning ..... 14

    Restraint System Attachment to Floor Track ..... 16

**Hybrid Safety Procedures** ..... 18

- Hybrid Battery Service ..... 18
- Disconnect Plug ..... 18
- Regular Battery Placement ..... 18
- Hybrid Battery Placement ..... 18
- Running Out of Fuel ..... 18

**Emergency Procedures** ..... 19

- Emergency Release Handle ..... 19
- Jack Pad Locations ..... 20
- Vehicle Towing Instructions ..... 20
- Emergency Tire Repair ..... 20

**Maintenance and Warranty** ..... 21

- Vantage Mobility Conversion Scheduled Maintenance Plan ..... 21
- Hybrid Battery Air Intake Vents and Filters ..... 22
- Maintenance Log ..... 23
- Vantage Mobility Limited Warranty ..... 26
- Vantage Mobility/Toyota Service Information Form ..... 30

---

# INTRODUCTION

**Congratulations on the purchase of your new Toyota Sienna Hybrid Minivan equipped with the manual rear-entry conversion.**

Vantage Mobility has designed and built your conversion with quality and safety in mind. We expect this new vehicle and conversion to provide you years of enjoyable transportation.

This manual is a supplement to your Toyota Owner's Manual. Please read both manuals as they contain important operational and safety information.

Your new vehicle may be equipped with special driving controls installed by your Vantage Mobility dealer to meet your individual driving needs. These may include hand controls, power assist brake and accelerator systems, and reduced effort steering and braking systems. Before driving the vehicle, you should obtain professional driver training on the proper use of these controls to understand how these modifications may affect the handling of your vehicle.

The Vantage Mobility conversion carries a limited warranty that covers the conversion modifications and alterations only. The Toyota vehicle carries a separate warranty. If a defect or a failure is a direct result of a Vantage Mobility modification, it will be covered under the Vantage Mobility Limited Warranty. A defect or failure on any original equipment NOT altered by Vantage Mobility is covered under the Toyota warranty. Please refer to the Vantage Mobility conversion maintenance requirements and the limited warranty information in this manual to familiarize yourself with the coverage and exclusions.

**SHOULD YOUR VEHICLE REQUIRE SERVICE OF ANY KIND, PLEASE CONTACT YOUR Vantage Mobility AUTHORIZED MOBILITY EQUIPMENT DEALER. TO LOCATE A DEALER IN YOUR AREA, PLEASE GO TO [VantageMobility.com](http://VantageMobility.com).**

## TRADEMARKS

Product names mentioned in this manual may be trademarks or registered trademarks of their respective companies and are hereby acknowledged.

## COPYRIGHT © 2024 VANTAGE MOBILITY, LLC

This manual is proprietary to Vantage Mobility, LLC (Vantage Mobility) and is intended for the exclusive use of Vantage Mobility customers. No part of this document may in whole or in part, be copied, reproduced, distributed, translated or reduced to any electronic or magnetic storage medium without the express written consent of a duly authorized officer of Vantage Mobility.

## DISCLAIMER

This manual was reviewed thoroughly for accuracy. All statements, technical information, and recommendations contained herein and in any guides or related documents are believed reliable, but the accuracy and completeness thereof are not guaranteed or warranted. They are not intended to be, nor should they be understood to be, representations or warranties concerning the products described.

Vantage Mobility is constantly improving its products and reserves the right to make changes in the specifications of products or in this manual at any time without notice and without obligation to notify any person of such changes.

## RECORD OF REVISIONS

| Document Number | Revision Level | Date     | Reason for Change |
|-----------------|----------------|----------|-------------------|
| DOC4303         |                | Jan 2024 |                   |

---

# SAFETY PRECAUTIONS

- Read your Vantage Mobility and Toyota Owner's Manuals before operating the vehicle or any of its conversion equipment. There is important safety and operational information you must know to operate this vehicle and its equipment properly. Failure to do so may result in property damage or bodily injury.
- In addition to reading the manuals, you must ensure your Vantage Mobility dealer instructs you on the use of your conversion and its safety features before operating the vehicle or the conversion.
- Please adhere to all securement related instructions in this manual and instructions made by the restraint manufacturer before operating the vehicle. Improper installation, adjustment or use may result in, and may not be limited to, the restraint system failing to perform as anticipated.
- Your vehicle has been fitted with a manual wheelchair-strap restraint system. You have been provided one set of four wheelchair restraint straps and one lap/shoulder belt extension strap. Though these restraints are widely used within our industry, they **DO NOT** guarantee successful and safe securement of wheelchairs or scooters.
- Restraints should not be held away from the body by any obstacles such as wheelchair armrests. Ensure nothing is between the restraints and the occupant.
- All wheelchairs and scooters, occupied or not, must be properly restrained prior to vehicle operation. Failure to do so may result in property damage or bodily injury.
- If you plan to occupy a wheelchair while the vehicle is in motion, Vantage Mobility cannot guarantee the restraint system will adequately restrain the occupant and/or wheelchair if an accident occurs at any speed. Vantage Mobility relies solely on the warranties and representations made by the restraint belt set and wheelchair manufacturers.
- Before operating the ramp, make sure the vehicle's transmission is in PARK and the parking brake is SET. Failure to do so may result in property damage or bodily injury.
- Do not operate the ramp, load, or unload the vehicle if traffic or road conditions do not allow you to do so safely.
- There must be approximately 8 feet of clearance at the rear of the vehicle to allow for safe ramp deployment and wheelchair plus occupant to be able to maneuver. Allow 4 feet additional clearance if assistance is required.



- The wheelchair occupant may require assistance entering and exiting the vehicle, depending on the abilities of the person and the type of wheelchair system (motorized, presence of rear wheels, etc.) or scooter.
- Before exiting the vehicle, the wheelchair occupant **MUST** check to make sure the door is open and the ramp is fully deployed to the ground.
- Before stowing the ramp and closing the door, the ramp and door area must be clear of operator and bystanders. **DO NOT** operate the ramp if any person or object is on it. Doing so may result in property damage or bodily injury.
- All occupied wheelchairs **MUST** be facing forward to be properly secured.
- **DO NOT** sit in a wheelchair without proper head and neck support while vehicle is in motion. Vantage Mobility cannot guarantee the safety of the wheelchair occupant if an accident occurs at any speed.
- **DO NOT** sit on a scooter while the vehicle is in motion.
- Stow-able seats must be properly secured, latched, and locked before occupying seats or operating vehicle.
- Your vehicle's fuel system has been modified by Vantage Mobility. Although the possibility of experiencing problems with the modified fuel system is unlikely, it is important that you be aware that these modifications were performed. If you experience any fuel system problems, contact your Vantage Mobility dealer or Toyota dealer immediately and discontinue the use of your vehicle until the issue is resolved.

### WARNING

**Please familiarize yourself with the safety information provided in this manual. If you have any questions or concerns regarding the proper operation of your vehicle or any of its safety features, please contact your Vantage Mobility dealer or call Vantage Mobility directly at 855-864-8267.**

### WARNING

**Beware of ramp slope!**

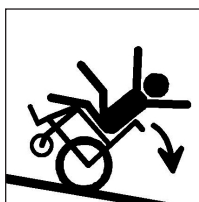

# EQUIPMENT GUIDE

To help you navigate this owner's manual, have your mobility dealer indicate the items or options installed on your wheelchair accessible conversion.

## VANTAGE MOBILITY INSTALLED EQUIPMENT

- Manual folding rear entry ramp
- Aluminum L-Tracks restraint tie-down system
- Interior emergency release handle
- Black Chroma Phantom 2.2mm Altro safety flooring
- Black carpet sidewalls
- Interior and exterior lighting meeting ADA CFR title49 Part 38 Subpart B
- Standard passenger-side 16" fixed Freedman seat
- Suspension OEM modified heavy duty coil springs
- Anti-Rattle device for ramp rattle reduction
- Rust-mitigating galvanized steel and e-coating
- Optional - Driver-side 16" fixed Freedman seat
- Optional - OEM (3) mid-row passenger seats\* (Taxi cut)
- Optional - running boards with anti-slip surface
- Optional - Transmission Shift Interlock
- Optional - Commercial ramp
- Optional - Back-up beeper

## VANTAGE MOBILITY MOBILITY DEALER INSTALLED EQUIPMENT

---

---

---

---

---

---

---

\* Patent pending

# RAMP OPERATION

Vantage Mobility's manual conversion is equipped with a manually operated door. The XLE model door can also be operated using the key FOB or an exterior button. Conversion also includes a folding ramp system. The ramp deploys from and stows into the rear hatch of the vehicle.

Before using the door and ramp, make sure the van is in PARK and the parking brake is SET. If this step is skipped, the van might move slightly until the transmission locks. This could be unsafe when entering/exiting the vehicle using the wheelchair ramp.

There must be approximately 8 feet of clearance at the rear of the vehicle to allow for safe ramp deployment and wheelchair plus occupant to be able to maneuver. Allow additional clearance if assistance is required.

## DEPLOY RAMP

1. Open the vehicle lift gate.  
*(Refer to your vehicle owner's manual for instructions on your specific vehicle's lift gate.)*
2. Release red toggle clamps on both sides of the ramp by pulling the red lever upwards towards the handle. Pull handle towards you enough for the latch to clear the ramp hooks.
3. Lift latch over ramp hooks and push away from you. Stow toggle clamps in the open unlocked position. You will hear an audible click when properly locked/stowed away.
4. To lower the ramp, stand to one side of the ramp and grab each of the two handles on that side. While pulling the ramp outwards away from the vehicle, unfold and fully straighten the two halves, guiding them downward until they contact the ground.

## WARNING

**You may experience some resistance deploying ramp due to spring tension.**

## WARNING

**Before operating the door and ramp, make sure the area to the rear of the vehicle is clear and unobstructed.**

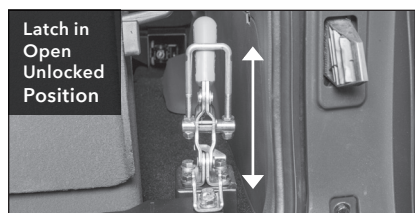
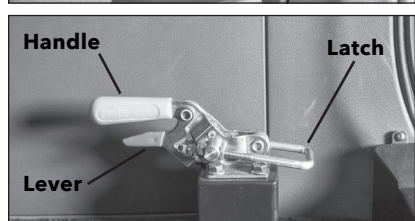
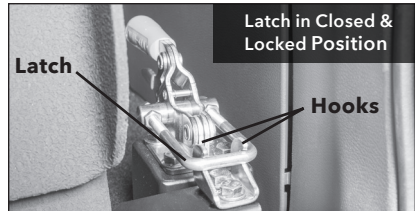

### WARNING

Van should not be driven with ramp deployed. Serious damage to vehicle, ramp, passenger or property could occur.

### WARNING

Ramp latch must be in the closed and locked position prior to closing the lift gate. Failure to do so may result in lift gate not closing securely.

## STOW RAMP

1. To stow the ramp, use the attached ramp handles with both hands. The handles can be utilized from either side of the ramp. Lift ramp off the ground and fold into the vehicle. Ramp will momentarily remain in place.
2. Secure the ramp in place by squeezing the lock release and pulling the toggle clamp and hook up and towards you. Place the latch on the ramp hook groove and push away from you until you hear an audible click. Complete this on both sides; this locks the red toggle clamps in place on both sides of the ramp.
3. Close the vehicle's liftgate by using the added strap for ease of closing the hatch. *(Refer to your vehicle owner's manual for instructions on your specific vehicle's liftgate.)*

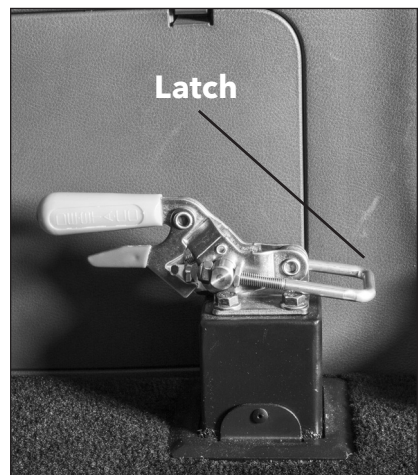
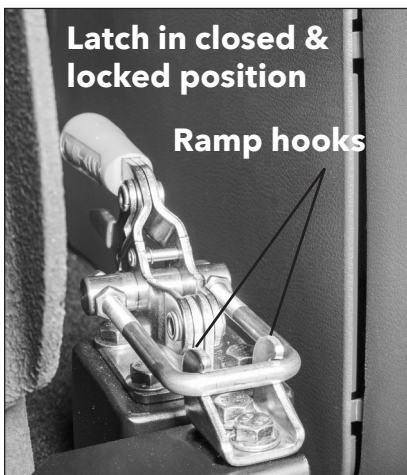

**WARNING**

**DO NOT** stow the ramp if a person or object is on the ramp. This could cause ramp system damage or serious bodily injury.

**WARNING**

Do not release the ramp handles, allowing it to fall to the ground or spring up, unrestrained/unassisted.

**WARNING**

Always use proper lifting techniques (i.e. bending with your knees and not your back) when raising or lowering the ramp.

**WARNING**

Please keep all body parts clear of ramp hinge, springs, and ramp mechanism. Do not insert body parts between ramp and tailgate.

---

# SEATING AND SECUREMENT

## WHEELCHAIR RESTRAINT SYSTEM

Vantage Mobility includes a wheelchair restraint system in every conversion to secure a wheelchair while the van is in motion. This belt system includes four adjustable over-center buckle belts and one lap belt extension. While this manual contains instructions on how to use the system, the kit included with your conversion contains a more detailed set of instructions. Read both and consult with your Vantage Mobility mobility dealer about the proper use of this system.

### Over-Center Belt (4 supplied)



### Lap Belt Extension (1 supplied)



## WARNING

The Vantage Mobility-supplied wheelchair restraint system meets the most widely referenced Federal Motor Vehicle Safety Standards used for contemporary restraint equipment. However, this equipment does not ensure stability of the wheelchair in the event of an accident at any speed.

### MID-ROW SEATING

- 16" passenger-side Freedman seat comes standard.
- Optional - 16" driver-side Freedman Seat.
- Optional - OEM 3 passenger seats\* (*Refer to your vehicle owner's manual for instructions on use, safety and maintenance.*)

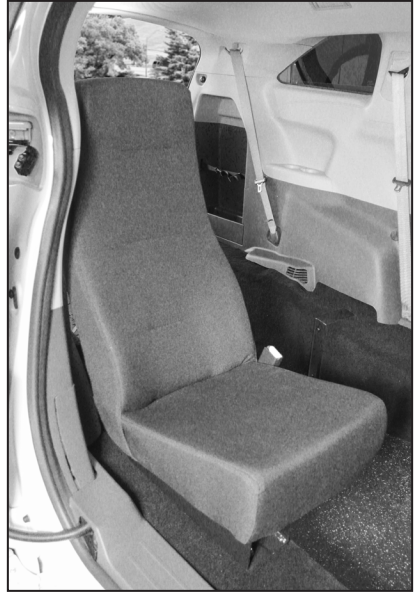
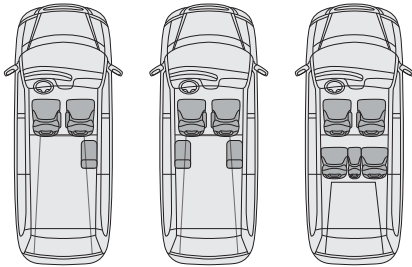

### CHILD RESTRAINT SYSTEM

Please refer to the OEM Toyota User's Manual on how to properly use the child restraint system ISO anchors with the single fixed mid-row seat and OEM mid-row seats.

### VEHICLE LOAD CAPACITY

**SAFETY WARNING:** Loading of passengers and cargo should never exceed vehicle limits.

It is important that any operator of the Vantage Mobility Toyota Sienna conversion vehicle understands that the installation of adaptive equipment has necessarily added weight to the original Toyota vehicle, thereby reducing the load carrying capacity of the original vehicle. While the vehicle, as manufactured by Vantage Mobility, meets all applicable Federal Safety Standards concerning vehicle loading, it is important that the load carrying capacity never be exceeded.

Owners and Operators should carefully monitor their loading of passengers and cargo (defined to include any and all additional weight added to the vehicle) to ensure that the capacity of the vehicle is never exceeded.

The load carrying capacity of this modified vehicle is found on the ***Tire and Loading Information Label*** located on the driver side front door jamb. It is important to know the capacity of your vehicle and that you and any operator of your vehicle monitor the loading of passengers and cargo to ensure that the weight capacity of the vehicle is not exceeded. Damage to the vehicle or vehicle systems from overloading may lead to catastrophic failure, either immediately or in the future, if this vehicle is operated in an overloaded condition.

In addition, a Vantage Mobility dealer or other adaptive equipment supplier may have added or installed adaptive equipment or other equipment to the vehicle. The primary user of the vehicle will likely use a mobility device (wheelchair or scooter). The total weight of this additional equipment and the mobility device must be included when calculating the combined load of cargo and passengers.

### WARNING

**Modifications to the original Toyota by Vantage Mobility and by any subsequent mobility dealer have reduced and limited the load capacity of the original vehicle. The total weight of passengers and cargo should never exceed the load capacity posted on the driver side door jamb. Overloading of the vehicle may negatively impact handling and could result in vehicle damage or failure while in use. It may not only cause damage to the tires, but also degrade steering and braking ability, resulting in an accident.**



## Steps for Determining the Load Limit of This Vehicle

1. Locate the statement *"The combined weight of the passengers and cargo should never exceed xxx kg or xxx lbs"* on the **Tire and Loading Information Label** in the vehicle, located on the driver side front door jamb.
2. Identify and determine the weight of all added adaptive equipment and mobility devices to be used in the vehicle. Consult your Vantage Mobility dealer if this is not clear to you.
3. Determine the driver, passengers, and other cargo in the vehicle.
4. Subtract the weight of all added equipment, mobility device(s), and the combined weight of the driver and passengers from xxx kg or xxx lbs posted on the Tire and Loading Information Label.
5. The resulting figure equals the available amount of cargo and luggage load capacity and should never equal 0 or a negative number.

**Example:** If xxx = 1500 lbs, the added equipment and mobility device = 240 lbs, and four 150lb passengers will be using, the amount of available cargo capacity is 660 lbs (since 4 passengers x 150 lbs = 600 lbs and 1500 lbs - 240 lbs - 600 lbs = 660 lbs). The total weight of additional passengers and cargo

should not exceed the remaining 660 lbs. Again, it is important to the safety of your vehicle, your passengers and those operating your vehicle, as well as those around you, that the owner and operator are always aware of the load capacity of your vehicle and confirm that the load capacity of the vehicle is not exceeded. Handling deterioration, vehicle damage, and vehicle failure while in use may occur if systems are overloaded. You are responsible for the safe operation of your vehicle!

### Your Calculations:

1. Total load capacity of your Vantage Mobility Toyota:

\_\_\_\_\_ lbs

2. Weight of your additional adaptive equipment and mobility devices and operator's weight (including wheelchair or scooter):

\_\_\_\_\_ lbs

3. Subtract line 2 from line 1.

Remaining capacity available for cargo and passengers on any trip:

\_\_\_\_\_ lbs

## RESTRAINT BELT POSITIONING

The photos below show the locations of the standard floor tracks.

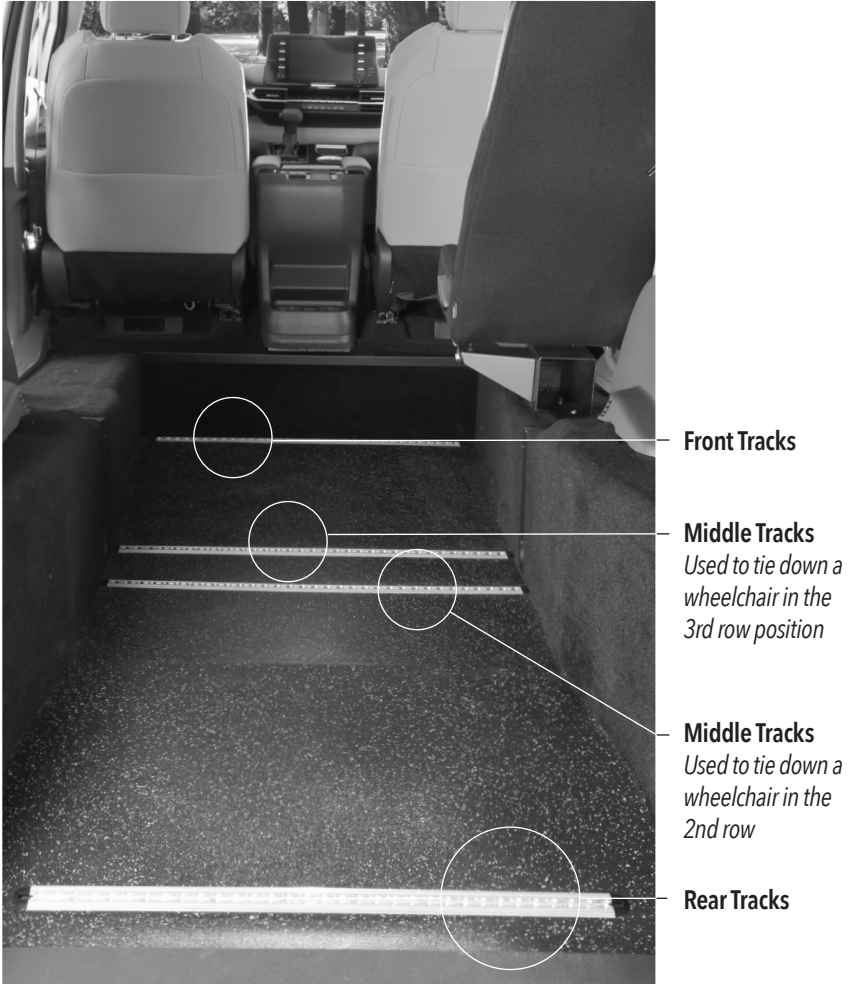

There must be a straight line from the anchorage to the wheelchair attachment for proper belt angles. See **Figure 7** for proper belt angles.

Attach the tie down to a solid frame member of the wheelchair.

Ensure belts are under tension and not loose or sagging.

Install the tie down anchorage with center-to-center distance as shown in **Figure 8**.

Do not allow belts to be twisted inside the belt retractor. The recommended center-to-center distances are based on common wheelchair sizes. Exceptionally large or small wheelchairs may require anchorage spacing that differs from this recommendation. Use the belt angles from **Figure 7** to determine exact placement of the tie down in the floor track.

Each of the four supplied tie downs secures the wheelchair to the vehicle's floor tracks. The seat belt extension is provided to use with the vehicle's seat belts.

**Figure 7**

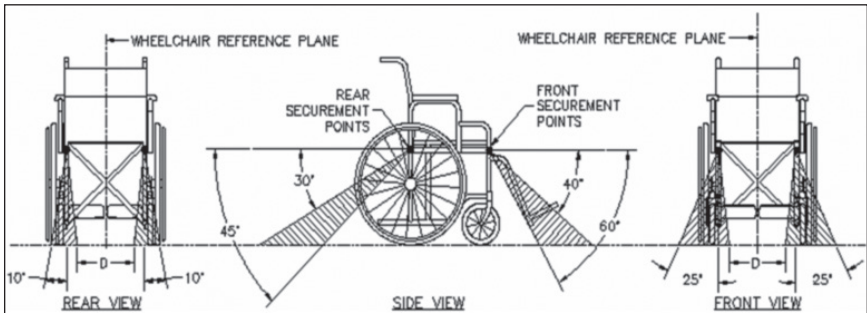

**Figure 8**

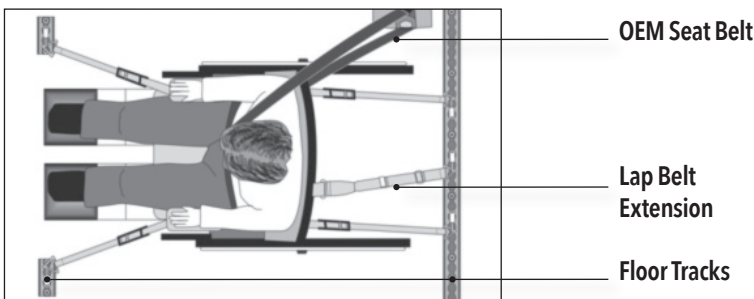

**Rear:** 13" to 15"    **Front:** 28" to 30"    **Front to Rear:** 44" to 54"

## SEATING AND SECUREMENT

### RESTRAINT SYSTEM ATTACHMENT TO FLOOR TRACK

#### Instructions for Use

1. Place wheelchair in the vehicle facing forward and in a suitable position.
2. Pre-select a position on the wheelchair to attach the hook and a position on the floor to attach the floor latch end of the strap.
3. Release the buckle latch on the strap. With the buckle released, pull the webbing to create enough slack that the restraint belt can be attached to the floor and the wheelchair. Attach the restraint belt to the wheelchair.



4. Connect the floor latch to the pre-selected location on the floor track by pushing the fitting with even pressure into the track and slide the fitting in one direction until the spring-loaded latch drops into place. Pull on the strap to make sure it is secure.



5. Find the handheld strap and pull to tighten the strap. Make sure there are no twists or knots in the strap.



6. Lock buckle by pushing down until the buckle latch locks in place.



7. Ensure the same procedure is followed for all of the designated positions.

## Lap and Shoulder Belts

To secure an occupant in a wheelchair, use the OEM seat belt in conjunction with the supplied lap belt extension. Clip the lap belt extension to the floor of the vehicle behind the wheelchair as shown in **Figure 8** on page 14. Insert the OEM seat belt tongue into the lap belt extension receptacle. When using the lap belt extension, do not route any belt over the side panel or the armrest of the wheelchair. The occupant must wear seat belts against the body and low across the front pelvis with the junction between the lap and shoulder belts located near the occupant's hips as shown in **Figure 9**.

Adjust the extension at the adjuster buckle. The lap and shoulder belts must not be held away from the body by the wheelchair or any of its components.

Adjust the belts firmly, consistent with user comfort. Use the vehicle belt height adjuster if necessary. The belts must not be twisted.

If the supplied lap and shoulder belts cannot secure the wheelchair occupant according to the instructions in this manual, contact your mobility dealer for other options.

**Figure 9**

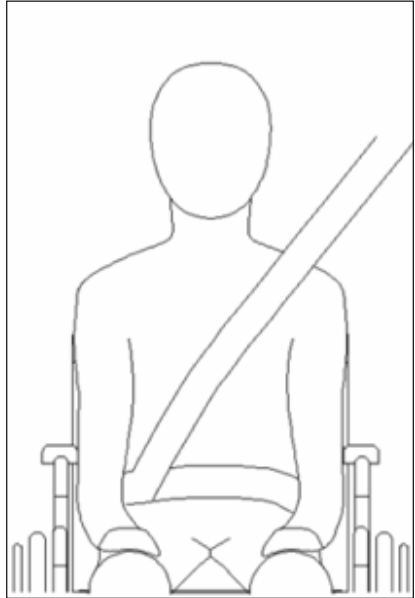

### WARNING

**If the belts do not restrain the body properly, the wheelchair must not be occupied during operation of the vehicle. Consult your mobility dealer if additional securement measures are necessary to ensure the wheelchair and occupant are secure.**

# HYBRID SAFETY FEATURES

## HYBRID BATTERY SERVICE

*(Refer to your vehicle owner's manual for information on your specific vehicle's hybrid battery information.)*

### **DISCONNECT PLUG REGULAR 12V BATTERY PLACEMENT REGULAR HYBRID BATTERY PLACEMENT**

Not modified by Vantage Mobility.

*(Refer to your vehicle owner's manual for information on your specific vehicle's hybrid battery information.)*

## **WARNING**

**Do not attempt to service hybrid related components on your own. Only service with a trained mechanic to avoid damaging the system.**

## **RUNNING OUT OF FUEL**

If there is only a small amount of fuel, the hybrid system may not be able to start.

The standard amount of fuel is about 3.1 gal. (11.9 L, 2.6 Imp. gal.), when the vehicle is on a level surface. This value may vary when the vehicle is on a slope. Add extra fuel when the vehicle is inclined.

---

# EMERGENCY PROCEDURES

## EMERGENCY RELEASE HANDLE



1. From the inside of the van, pull the red handle located at the base of the rear hatch window.
2. The van operator must deploy the ramp from the rear of the van after the release is pulled.
3. The passenger can now exit the vehicle.

### **JACK PAD LOCATIONS**

The front and rear jack pads have not been affected by the conversion (OEM location). Consult your Toyota Owner's Manual for information regarding the front jack pad location.

Using the OEM jack to lift the minivan from any other location may result in damage to the vehicle frame and/or conversion components and could result in serious bodily injury.

Dependant on model, the vehicle may have the optional spare tire or an inflation kit. Refer to your Toyota owner's manual for their specific locations. The jack is located under the fixed passenger mid row seat. The lug wrench is located on the inside of the 12V battery door.

### **EMERGENCY FLAT TIRE REPAIR**

Standard equipment on the Vantage Mobility Toyota conversion is a tire sealant and inflation kit. These kits are widely used by auto manufactures in lieu of a spare tire and jack due to space constraints in modern vehicles

### **Sealant and Inflation Kit**

To repair a flat tire using the supplied tire sealant and inflation kit, locate and remove the kit from the storage compartment located in the vehicle's rear cargo area. Open the kit and follow the supplied instruction sheet. Refer to your Toyota Owner's Manual for detailed information concerning safety and the use of this equipment.

### **VEHICLE TOWING INSTRUCTIONS**

Refer to your Toyota Owner's Manual for proper vehicle towing instructions.



# MAINTENANCE & WARRANTY

It is important to perform scheduled inspection and maintenance on Vantage Mobility conversion products and restraint components to provide safe and trouble-free operation and to comply with the Vantage Mobility Limited Warranty. The following is the required minimum maintenance schedule to be followed.

**NOTE:** Vehicles operated in environments subject to snow, road sand and salt, dust, rain, and temperature extremes may require maintenance that is more frequent.

## VANTAGE MOBILITY CONVERSION SCHEDULED MAINTENANCE PLAN

**Must be Performed Every 6 Months or 750 Ramp Cycles by an Authorized Vantage Mobility Dealer**

### Ramp System and Normal Wear

- Inspect ramp mechanism for loose fittings, alignment, and abnormal wear.
- Clean and lubricate ramp pivot pins as needed.
- Lightly lubricate ramp hinges with non-silicon spray grease.
- Inspect weather strip for wear and damage.
- Inspect and replace normal wear items as required.

*Expenses associated with the above scheduled maintenance are not covered under the Vantage Mobility limited warranty program.*

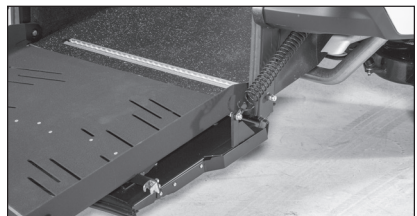
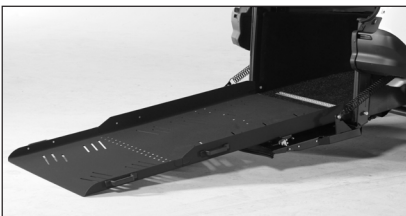
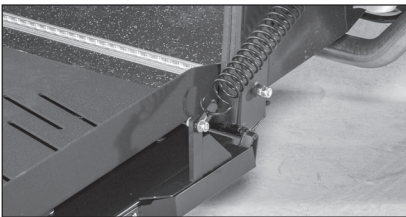

**Must be Performed Every 12 Months or 1,500 Ramp Cycles by an Authorized Vantage Mobility Dealer**

**Ramp System, Undercarriage and Normal Wear**

- Inspect ramp mechanism for loose fittings, alignment, and abnormal wear.
- Clean and lubricate ramp pivot pins as needed.
- Lightly lubricate ramp hinges with non-silicon spray grease.
- Inspect weather strip for wear and damage.
- Check undercarriage for component damage.
- Check undercarriage for rust or corrosion and repair as needed.
- Inspect and replace normal wear items as required.

*Expenses associated with the above scheduled maintenance are not covered under the Vantage Mobility limited warranty program.*

**HYBRID BATTERY AIR INTAKE  
VENTS AND FILTERS**

Not modified by Vantage Mobility.

*(Refer to your vehicle owner's manual for information on your specific vehicle's hybrid battery intake vents and filters maintenance and warranty.)*

## MAINTENANCE LOG

Record maintenance information in the table below.

DATE

---

DESCRIPTION

---

---

---

DEALERSHIP

---

DATE

---

DESCRIPTION

---

---

---

DEALERSHIP

---

DATE

---

DESCRIPTION

---

---

---

DEALERSHIP

---

DATE

---

DESCRIPTION

---

---

---

DEALERSHIP

---

## MAINTENANCE & WARRANTY

---

DATE

---

DESCRIPTION

---

---

---

DEALERSHIP

---

DATE

---

DESCRIPTION

---

---

---

DEALERSHIP

---

DATE

---

DESCRIPTION

---

---

---

DEALERSHIP

---

DATE

---

DESCRIPTION

---

---

---

DEALERSHIP

---

## MAINTENANCE & WARRANTY

---

DATE

---

DESCRIPTION

---

---

---

DEALERSHIP

---

DATE

---

DESCRIPTION

---

---

---

DEALERSHIP

---

DATE

---

DESCRIPTION

---

---

---

DEALERSHIP

---

DATE

---

DESCRIPTION

---

---

---

DEALERSHIP

---

### VANTAGE MOBILITY LIMITED WARRANTY

The Vantage Mobility LIMITED WARRANTY modifies the standard Toyota LIMITED WARRANTY on this vehicle. Modifications to the vehicle made by Vantage Mobility, components installed by Vantage Mobility, and Toyota components and systems affected by Vantage Mobility modifications and components are NOT covered by the Toyota LIMITED WARRANTY.

Vantage Mobility offers one of the most extensive conversion service warranties in the mobility industry. Our warranty, outlined herein, warrants the structural metal fabrication on or of the Vantage Mobility frame and components against rust through, or failure due to rust corrosion for a period of 7 years for unlimited vehicle odometer miles. Surface corrosion on weld joints are excluded. Corrosion that resulted from damage to the conversion are excluded. **Prior to filing a claim for rust-through or corrosion, the owner must provide verification of timely maintenance inspection for corrosion outlined in the Maintenance Schedule of this manual.**

**NOTE:** Applies to 2021 model year chassis and newer with new conversions.

The time periods will commence upon first delivery of the vehicle from Vantage Mobility or a Vantage Mobility dealer to the initial retail purchaser of the vehicle or the date that the vehicle was first placed into service, whichever comes first. Note that the Vantage Mobility Limited Warranty, which covers the Vantage Mobility conversion, is separate from the Toyota Limited Warranty, which covers components of the Toyota vehicle not affected by the conversion process.

The Vantage Mobility Limited Warranty will commence on the date the converted vehicle is delivered to the end-user. The Vantage Mobility warranty will be 36 months or 36,000 miles from the Odometer reading at the time of conversion. The 36 month, 36,000 mile Toyota Limited Warranty commences when the vehicle was originally sold to the first retail purchaser. Subject to the terms of the Vantage Mobility Limited Warranty, Vantage Mobility will repair or replace any Vantage Mobility factory installed part that is found to be defective within the above stated warranty period. Vantage Mobility will reimburse Vantage Mobility factory authorized repair facilities for labor costs associated in the repair or replacement of defective parts or workmanship. The reimbursement may be based on a Vantage Mobility "Flat Rate Schedule." Warranty work that is performed at a facility that is NOT an authorized Vantage Mobility Service Facility will

only be reimbursed to the amount determined by the flat rate schedule or a labor rate as determined by Vantage Mobility. Vantage Mobility reserves the right to designate where warranty work is to be performed and reserves the right to inspect any claim of defective workmanship or parts prior to authorization of repairs. Vantage Mobility makes no guarantee or representation as to the location of the nearest Vantage Mobility dealer or as to the convenience of having work done at such location. The Vantage Mobility Limited Warranty does not apply to parts or workmanship that becomes defective due to misuse, neglect, abuse, normal wear and tear, or accident by the operator of the vehicle or by unauthorized repair work.

For your approved Vantage Mobility factory authorized repair facility, you can go to our website at **Vantage VantageMobility.com** or contact us by mail or telephone:

**Vantage Mobility Customer Advocate Center**  
**5202 S. 28th Place**  
**Phoenix, AZ 85040**  
**855-864-8267**

### **Transfer of Warranty**

If the vehicle is sold, the remainder of the Vantage Mobility Limited Warranty may be transferred to the second owner within 90 days of the purchase. To transfer the warranty, the new owner must send a written request to Vantage Mobility, including full name, address, phone number, and the Vantage Mobility ID number located on the inside driver door jamb.

### **Design Changes**

Vantage Mobility reserves the right to make design or process changes to improve its current product without any obligation to update or retrofit previously converted vehicles.

**Shipments of parts under the Vantage Mobility Limited Warranty will be sent by ground UPS only. If you request overnight or second-day shipment, that shipment will be sent freight collect.**

Vantage Mobility will deny warranty coverage without notice if it learns that a vehicle is ineligible for coverage for any of these reasons.

This Warranty does not cover maintenance of the Vantage Mobility conversion. Maintenance shall be performed at owner's expense.

Vantage Mobility neither assumes, nor authorizes, any person to assume for it, any obligation or warranty other than herein stated.

### Exclusion of Other Warranties

This warranty is exclusive and in lieu of any warranty of merchantability, fitness for a particular purpose, or other warranty of quality, whether express or implied, and of all other liabilities and obligations on the part of Vantage Mobility.

### Warranty Registration Requirement

The warranty registration card must be completed by the Vantage Mobility dealer and returned to Vantage Mobility within 10 days of vehicle delivery to the customer, along with the Vantage Mobility Pre Delivery Inspection checklist to validate any of the above stated warranties.

### Your Rights Under State Law

This warranty gives you specific legal rights, and you may have other rights that vary from state to state.

### Summary of Warranty Coverage

**Structural (Rust / Corrosion):**  
Warranted for 7-Years (unlimited miles) from rust-through corrosion

(perforation) of the structural metal fabrication on or of the VMI frame and components on new conversions from vehicle delivery date. Surface corrosion on weld joints are excluded. Corrosion that resulted from damage to the conversion are excluded.

**NOTE:** Applies to 2021 model year chassis and newer with new conversions.

**Electrical:**

3 Years / 36,000 Miles\* Parts and Labor

**Modified Seat Bases:**

3 Years / 36,000 Miles\* Parts and Labor

**Ramp System:**

3 Years / 36,000 Miles\* Parts and Labor

**Vantage Mobility Mechanical & Structural Conversion:**

3 Years / 36,000 Miles\* Parts and Labor

**Vantage Mobility Fabricated & Installed Equipment:**

3 Years / 36,000 Miles\* Parts and Labor

*\*Whichever occurs first*



### **How to Obtain Warranty Service**

If you encounter any difficulties with your vehicle, you should first contact the Vantage Mobility Mobility Equipment Dealer (“MED”) from whom you purchased the vehicle or, if you are outside that MED’s local area, the nearest Vantage Mobility MED. A list of Vantage Mobility MEDs can be obtained by dialing 855-Vantage Mobility-VANS (864-8267).

If the Vantage Mobility MED believes that your problem would more effectively be dealt with by an authorized Toyota dealership (for example, if the problem pertains to automotive parts covered by the Toyota LIMITED WARRANTY), you will be referred to a local Toyota dealership for warranty service. If the vehicle cannot be operated safely, transportation of your vehicle to and from the Toyota dealership will be arranged by the MED and you will be advised by the MED where and when to pick up your vehicle. If the vehicle can be safely operated, it may be more efficient for you to drive the vehicle to the designated Toyota dealership for warranty service, in which case you should make certain that the MED fills out the Service Information Form, and you should bring it to the designated Toyota dealership.

If you are unable to bring the vehicle to a MED and need to bring it to a Toyota dealer (for example, if you experience a problem where there is no MED nearby), please present the Service Information Card (pg 30) to the Service Manager of the Toyota Dealer. If you require help with this warranty or have any questions or comments, please contact Vantage Mobility at:

**Vantage Mobility Customer Advocate Center**  
**5202 S. 28th Place**  
**Phoenix, AZ 85040**  
**855-864-8267**

**VANTAGE MOBILITY/TOYOTA SERVICE INFORMATION FORM**

**Dear Toyota Dealer Service Manager:**

The Toyota customer presenting this form to you is the owner of a Toyota vehicle converted by VMI Holdings, LLC (Vantage Mobility) for wheelchair access and/or other mobility features. The vehicle has been brought by the customer to the Vantage Mobility Mobility Equipment Dealer ("MED") listed below where it has been determined that the repair sought by the customer is most likely covered by the Toyota Limited Warranty and should be performed by an authorized Toyota Dealer.

---

---

---

---

**Description of Customer Problem(s):**  
**MED Diagnosis:**

---

---

---

---

If you have any question about this diagnosis please contact the MED at:

**MED Name:** \_\_\_\_\_

**MED Phone Number:** \_\_\_\_\_

**Contact Person:** \_\_\_\_\_

If you believe that the service sought by the customer involves modifications to the vehicle made by Vantage Mobility, components installed by Vantage Mobility, or Toyota components and systems affected by Vantage Mobility modifications or components, you should contact Vantage Mobility Technical Support at **1-800-488-9082** prior to performing any service to determine whether Vantage Mobility or Toyota is responsible for the repair and whether you should make the repair or have the vehicle shipped to a Vantage Mobility repair facility. If you have any questions relating to this repair, you may also contact Toyota Technical Support at 1-800-247-9753.

Please photocopy this form for your records and return the original to the owner.







---

---

---

---

---

---

---

---

---

---

---

---

---

---

---

---

---

---

---

---

---

---

---

---

---

---

---

---

---

---

---

---

---

---

---

---

---

---

---

---

---

---

---

---

---

---

---

---

---



---

---

---

---

---

---

---

---

---

---

---

---

---

---

---

---

---

---

---

---

---

---

---

---

---

---



855-864-8267 • [VantageMobility.com](https://www.VantageMobility.com) • 5202 S 28<sup>th</sup> Place **Phoenix, AZ** 85040